

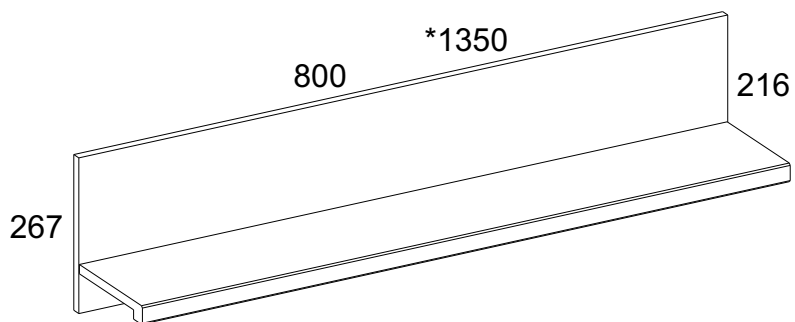

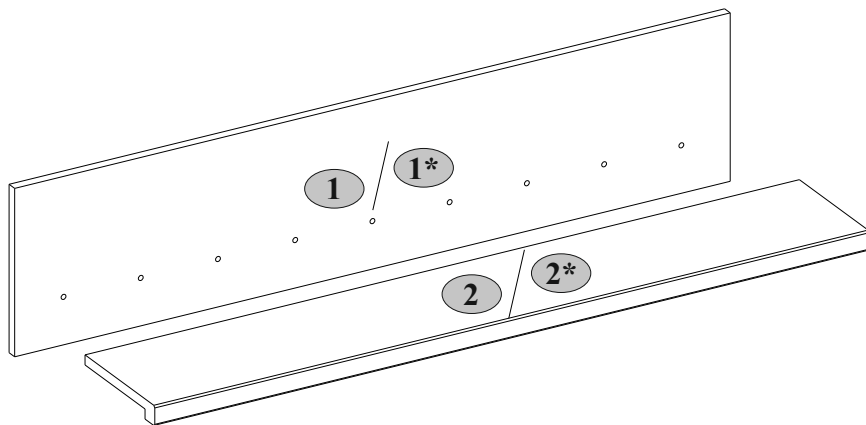



DORSI 80/135



	L, mm	B, mm	H, mm	Q	
1	800	267	16	1	1/1
2	798	200	32	1	1/1
1*	1350	267	16	1	1/1
2*	1348	200	32	1	1/1

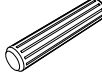

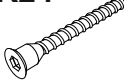

B3  Ø35 2	B4-1  10x50 2	C1  8x35 2, *4
I  S4 1	R24  7x50 3, *5	R27  5,0x13 6

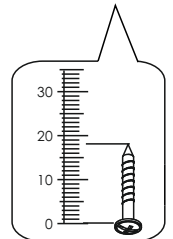
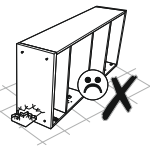
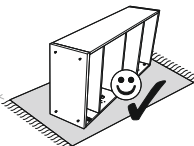
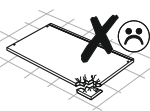
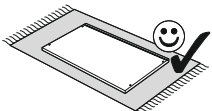
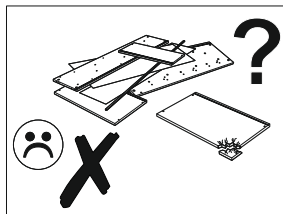
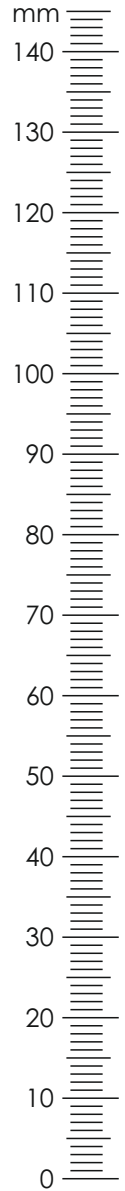
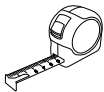
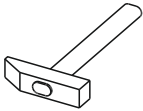
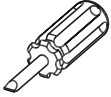

1

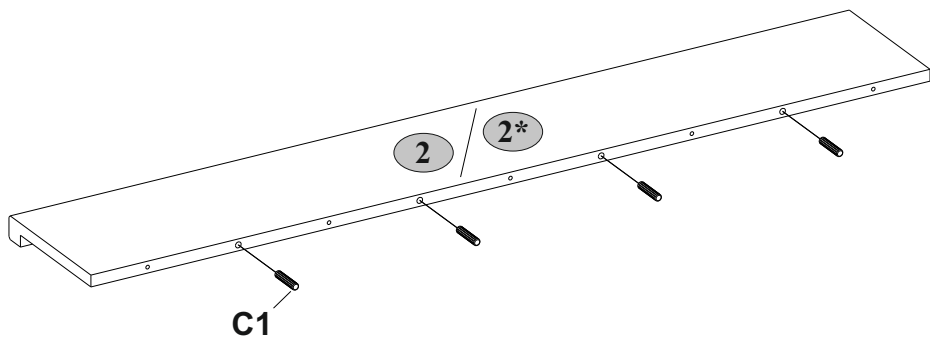
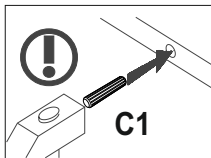
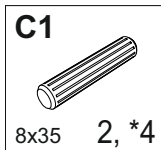

2

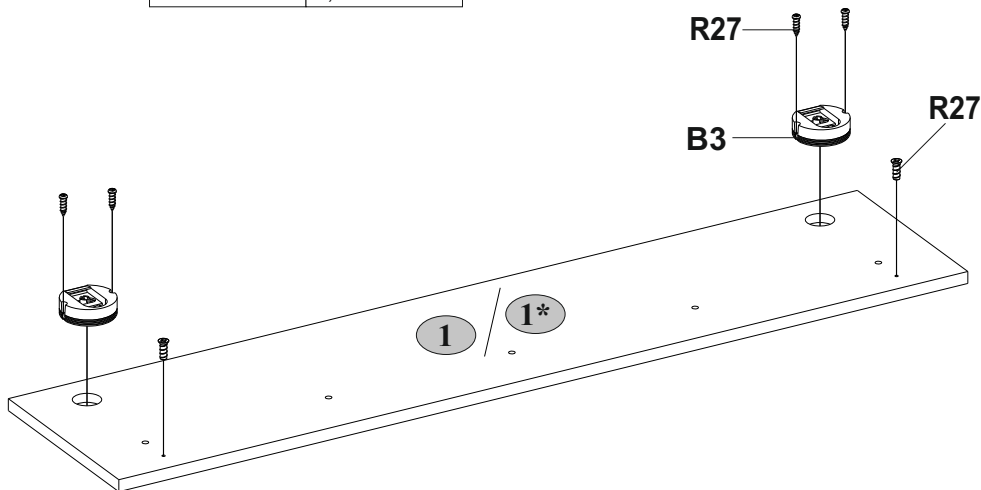
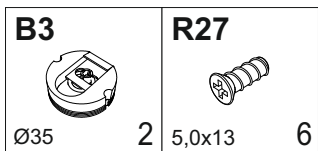

3

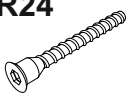
I  S4	R24  1 7x50 3, *5
---	---

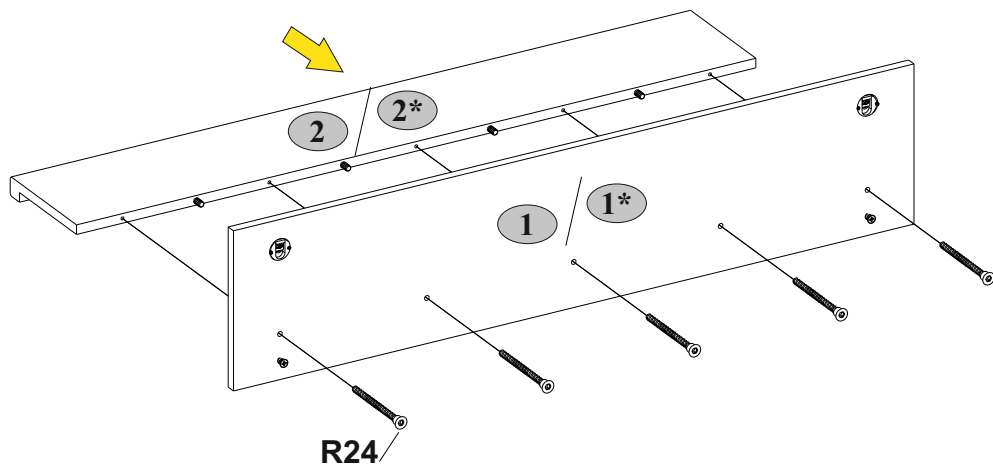
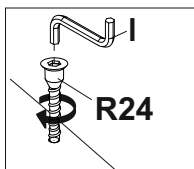

4

B4-1

10x50

2

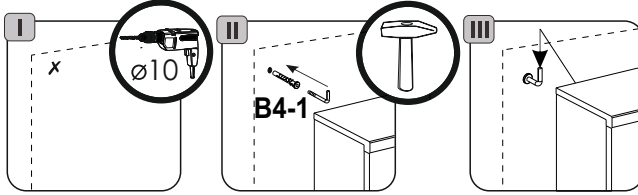
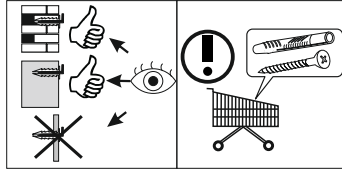

2 / 2* max. 3 kg

